

SL44 83" HD

All dimensions are measured in inches and [millimeters] from the top of the door to the centerline of the holes and ATW panels.

Choose location for ATW prep. ATW4 = 1 location; ATW8 = 1 location; and ATW12 = 1 location.

NOTE: For 90-degree openings, please specify at time of order for no upcharge. There will be an upcharge for 90-degree ATW cover plates when ordered separately and clear or bronze must be specified.

SL44 Profile

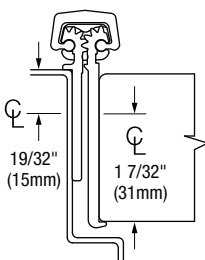
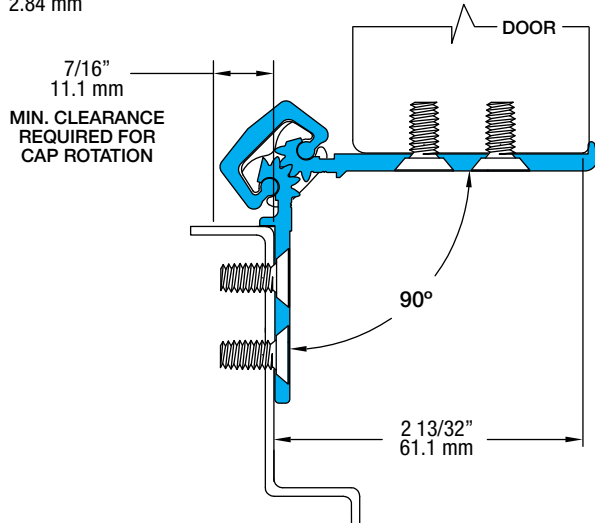
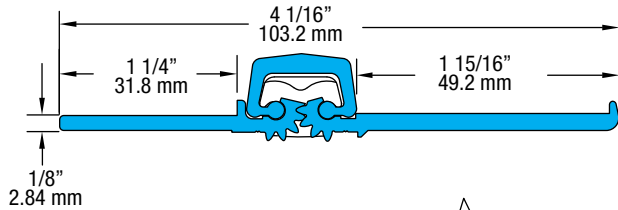
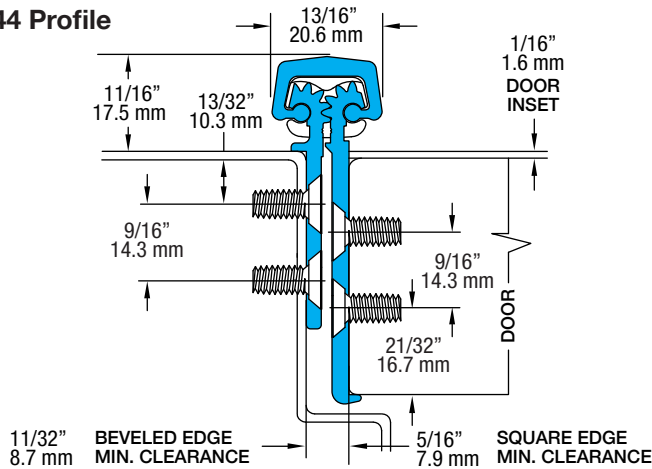

A 3/4" (19mm) clearance hole is required in the door and frame for the ATW wires.

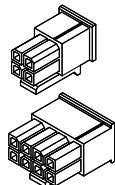

4-pin and/or 8-pin connectors are supplied at the end of the 8" (203.2mm) lead.

38 fasteners / 32 bearings

