

# SL315 Concealed Pin & Barrel Hinge

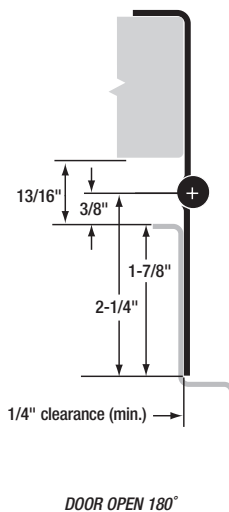
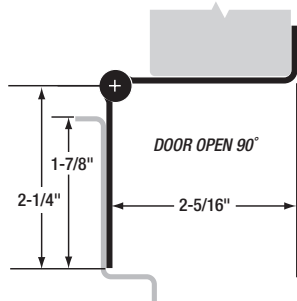
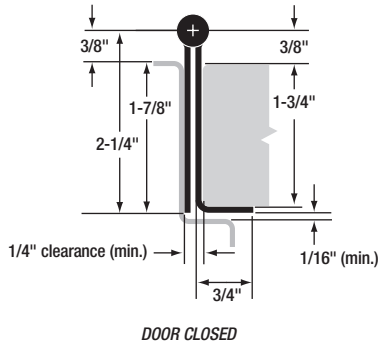

**MATERIAL:** 14 gauge 304 stainless steel with 3/16" diameter 304 stainless pin. Long-life nylon medical bearings.

**LENGTHS:** 79", 83", 85", 95" and 119" lengths standard for nominal door heights. Custom lengths are available.

**LOAD/FREQUENCY:** For 1-3/4" doors, 48" wide (max.), weighing up to 400 pounds (medium-frequency) without frame or door reinforcement; up to 600 pounds (low-frequency) without frame or door reinforcement.

**FINISH:** US32D satin stainless steel (630).

**CLOSERS:** Conventional overhead surface, concealed sliding arm overhead or floor closers may be used with SELECT hinges. Pivot-type floor closers (with a fixed, conflicting center pivot) must be replaced.

**ORDER:** Specify hinge length. Screw pack contains 12-24 x 7/8" 410SS Phillips flathead undercut self-drilling Tek® screws and 10 x 1-1/4" 410SS Phillips flathead undercut sheet metal screws.

**AVAILABLE ELECTRIC PREPS:** CTP-AR, CTP-VD, EL, AMS and ETAP.

**BHMA CERTIFICATION:** SL315 pin & barrel continuous hinges conform to BHMA Standard ANSI/BHMA A156.26-2006 Grade 1.



### SL315 HINGE SCREW COUNT

HINGE LENGTH	DOOR SCREWS	FRAME SCREWS
79"	18	18
83"	21	21
85"	18	18
95"	23	23
119"	27	27

# SPECIFICATIONS

## SL315 Concealed Pin & Barrel Hinge



### SELECT ADVANTAGES



**ZINC PLATED CARBON STEEL**  
Carbon steel with a stainless steel pin creates a tough, highly secure opening.

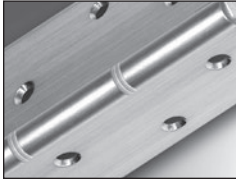

**TEMPLATED HOLE PATTERN**  
SELECT hinges line up perfectly, precisely, every time. Makes installation easier and faster.

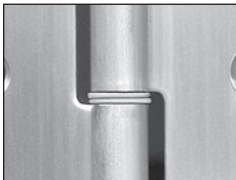

**DUST-FREE (MEDICAL) BEARINGS**  
Prevent metal-to-metal contact and eliminate dust. Exclusive standard (no upcharge) on all SELECT Pin & Barrel hinges.



**VARIETY OF FINISHES**  
Available in polished, brushed and painted finishes to match, contrast or accent your building's design.

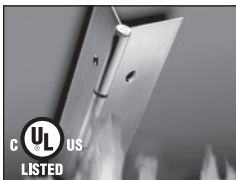

**3-HR. FIRE RATING**  
Fire-rated out of the package. No extra parts to buy or install. No liability worries.

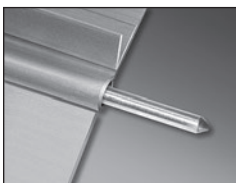

**STAINLESS STEEL PIN**  
Delivers high tensile strength by forming a strong, free-moving unit. Flexible and strong in abused openings.



**END CAPS**  
Spiral-knurled steel caps seal the barrel ends to contain hinge pin.

### SELECT HINGE PERFORMANCE

- SELECT pin & barrel continuous hinges are built to handle abuse from high-traffic applications. They are applied to the surface on the edge of the frame and door. No machining or reinforcement is required.
- On conventional hinges, opening and “kick-back” energy concentrate on a few inches of fastened reinforcing plate — with the top hinge handling 100% of the force. Pinless SELECT hinges bond the door and frame into an integrated, sag-free unit. “Kick-back” energy dissipates along the entire length of the door and frame. (Compare this to a conventional hinge’s 4-1/2" to 5" at the top of the door and frame).
- SELECT pin & barrel continuous hinges eliminate the gap between the door and frame, providing a weatherproof, rust-proof, tamper-proof barrier.
- SELECT pin & barrel continuous hinges (excluding Toilet Partition hinges) are listed and tested by Underwriters Laboratories to meet the Positive pressure requirements of UL10C, and are in accordance with UBC 7.2 (1997). SELECT pin & barrel continuous hinges (excluding Toilet Partition hinges) are for use on swinging single fire doors (max. door opening of 4'x10') or pairs of fire doors (max. door opening of 8' x10'), including double egress, installed in masonry or drywall. SELECT pin & barrel continuous hinges (excluding Toilet Partition hinges) are rated for 20 minutes on labeled wood doors, 1-1/2 hours for labeled hollow metal and composite-core wood fire doors, and 3 hours (NO FIRE PINS OR STUDS REQUIRED) for labeled hollow metal doors mounted singly only.

